

# YAMAHA PA SYSTEMS

**PM-200B** (PA Mixer)

**PS-100B/75B** (PA Amp/Speakers)



**Owner's Manual**

# PRECAUTIONS

You may seriously damage any transistorized audio unit by being careless when you first operate it. Carelessness is the major cause of audio repairs. Avoid disappointment by following the precautions listed here BEFORE plugging in or attempting to operate your PA system.

- Before you plug in the power cord please check that the voltage selector is set to your local current. If not properly set, turn the knob and reset it to the correct voltage position. Voltage settings: 110, 130, 220, 240V. U.S., Canadian, European and Australian models are set to the proper voltage before shipment.

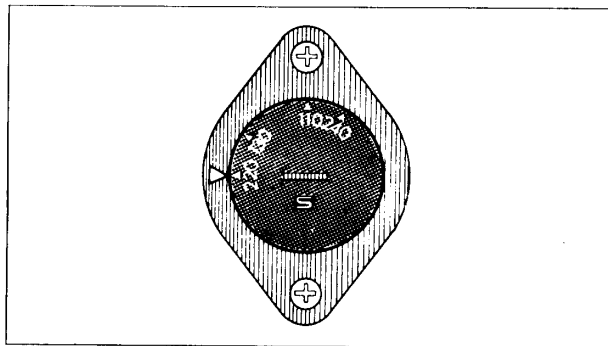

- Make sure the power switch is off before plugging in the power cord.
- Unplug the power cord as a safety measure, or at the very least be sure the power switch is off, before connecting or disconnecting any cords.
- Protect all units from heat, humidity, dust and shocks, as well as direct sunlight or other sources of heat.
- Be sure there is sufficient space around, behind and under each unit for proper ventilation.
- Do not switch input selectors while the amp is in use.
- The cannon connector used by Yamaha is wired according to the following system:

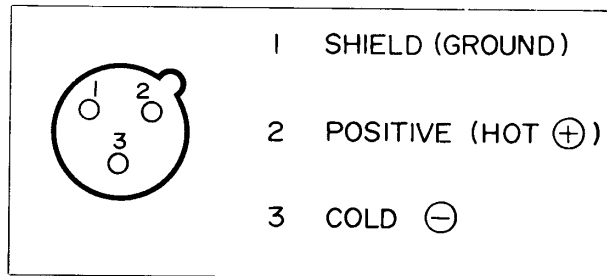

# PM-200B REAR PANEL PARTS & OPERATION

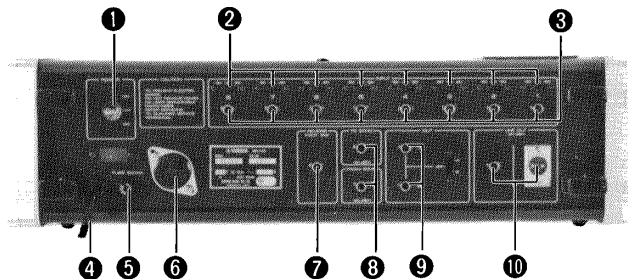

## ① Power Switch

Pick the ON position which affords the lower hum level. (except European and Australian models)

## ② Input Selectors

Use the selector to match that channel's input sensitivity to the output of the microphone connected to it.

## ③ Input Jacks

These jacks are telephone type connectors for low impedance microphones.

## ④ Power Cord

## ⑤ Fuse

Replace with a fuse of the same value.

## ⑥ AC Outlet (not provided in certain areas)

## ⑦ Reverb Foot Switch Jack

Use this jack to connect an optional foot switch for quick-action reverb and echo on/off control in any setting.

## ⑧ Echo Jacks (To Echo, From Echo)

These are the most practical jacks when connecting to an echo unit. Connect the To Echo (level:  $-30\text{dBm}$ ) to the echo unit input, and connect the echo unit output to the From Echo jack (level:  $-20\text{dBm}$ ).

## ⑨ Out Jacks

These are the output jacks for sending the mixed signal to PA type power amp/speaker. They have a two-way ( $-6\text{dBm}$ ,  $+4\text{dBm}$ ) switch to adjust the output level.

## ⑩ Line Out Jack and Socket

These are of course useful for recording a mixed signal, but they can also be used when the PM-200B serves as a sub-unit connected to another mixer.

# CONNECTION DIAGRAM

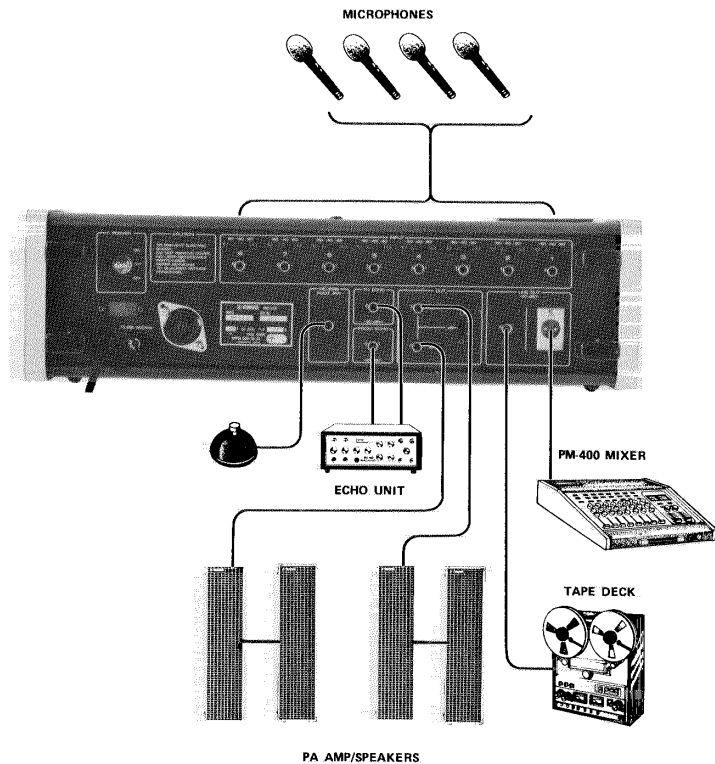

# PM-200B FRONT PANEL PARTS & CONTROLS

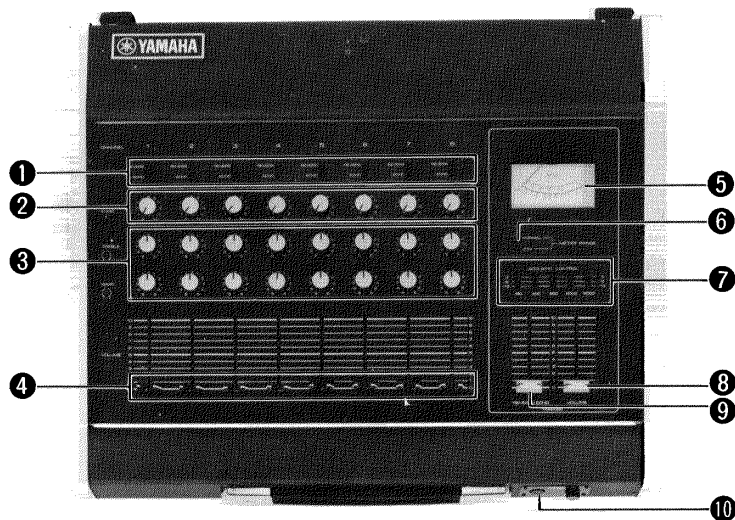

## OPERATION

### ① Reverb/Echo Selectors

Each channel has its own Reverb/Echo selector, which works for both effects: the built-in Reverb and Echo which is achieved by installing a special echo unit.

### ② Reverb/Echo Controls

Control the reverb or echo intensity for that channel.

### ③ Tone Controls

Each channel has its own Treble and Bass tone controls, which affect each end of the frequency scale. Turning either knob clockwise accentuates the tones (high or low) controlled by that knob.

### ④ Volume Controls

These slide-lever controls provide professional, quick-glance control of the signal output for that channel. Slide the lever up to increase the volume.

### ⑤ VU Meter

This meter shows the volume level of the output signal from the Out jacks.

When the needle centers around the "0" on the dial, the output is at the ideal level.

### 6 VU Meter Range Selector

This switch controls the sensitivity of the VU meter. Set it according to the following table.

Switch Setting	Out Jack Level Switch Setting	Out Jack Level	VU Meter Indication (VU)
NORMAL	-6	-9dBm(0.28V)	0
	+4	+4dBm(1.23V)	0
LOW	-6	-19dBm(87mV)	0
	+4	-6dBm (0.39V)	0

### 7 Acoustic Control

There are three Acoustic Control settings (0, -6 and -12dB) for each of the five separate controls: 150, 400, 900, 2000 and 5000Hz. You can obtain optimum frequency response in any location by adjusting this control. If howling occurs, this control can serve as a howling suppressor by lowering the level of selected frequencies.

### 8 Master Volume Control

Use to control the combined volume from all channels going to the Out jacks. Note that the Line Out signal is not affected by this knob.

### 9 Master Reverb/Echo Control

Adjust the overall intensity of the effect.

### 10 Phones Jack

This jack can be used for stage or other monitoring. It has its own volume control; turn to the right to increase the volume.

# PM-200B BLOCK DIAGRAM

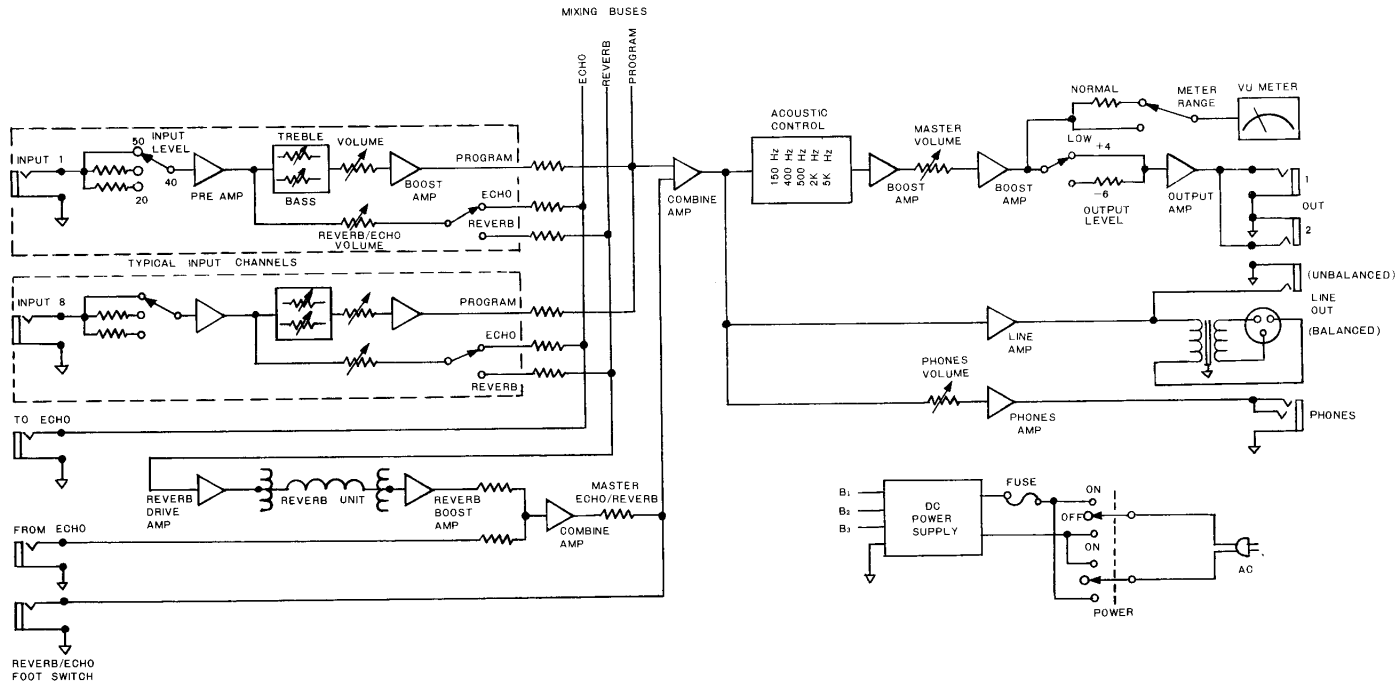

# PM-200B SPECIFICATIONS

<b>CHANNELS</b>	8
<b>CHANNEL CONTROLS</b>	Volume, Bass, Treble, Input Selector, Reverb/Echo, Reverb/Echo Selector
<b>MASTER CONTROLS</b>	Volume, Reverb/Echo, Acoustic Control, VU Meter Range Selector, Headphone Volume, Power Switch
<b>FITTINGS</b>	Input Jacks, Line Out Socket, Line Out Jack, Output Jacks (1, 2) w/Level Selector, To Echo/From Echo Jacks, Reverb Foot Switch Jack, Headphone Jack, VU Meter w/Pilot Lamp
<b>CIRCUITRY</b>	Solid State
<b>POWER CONSUMPTION</b>	10W
<b>FREQUENCY RESPONSE</b>	$\pm 0.4$ dB; 20 ~ 20 kHz
<b>DIMENSIONS (W x D x H)</b>	50.9 x 43.7 x 15.4cm (20 x 17¼ x 6")
<b>WEIGHT</b>	11 kg (24.2 lbs.)

<b>TERMINALS</b>		<b>NOMINAL LEVEL</b>	<b>IMPEDANCE</b>
<b>Input</b>		-20, -40, -50 dBm (78, 7.8, 2.4mVrms)	3K $\Omega$ (-50), 8K $\Omega$ (-40), 50k $\Omega$ (-20)
<b>From Echo</b>		-20dBm (78mVrms)	50K $\Omega$
<b>Out</b>		-6, +4dBm (0.39, 1.23Vrms)	70 $\Omega$
<b>Line Out</b>	<b>Phone Jack</b>	-20dBm (78mVrms)	70 $\Omega$
	<b>Cannon Type XLR-3-32</b>	-20dBm (78mVrms)	210 $\Omega$ (balanced)
<b>To Echo</b>		-30dBm (24mVrms)	5K $\Omega$



## PS-100B/75B REAR PANEL PARTS & OPERATION

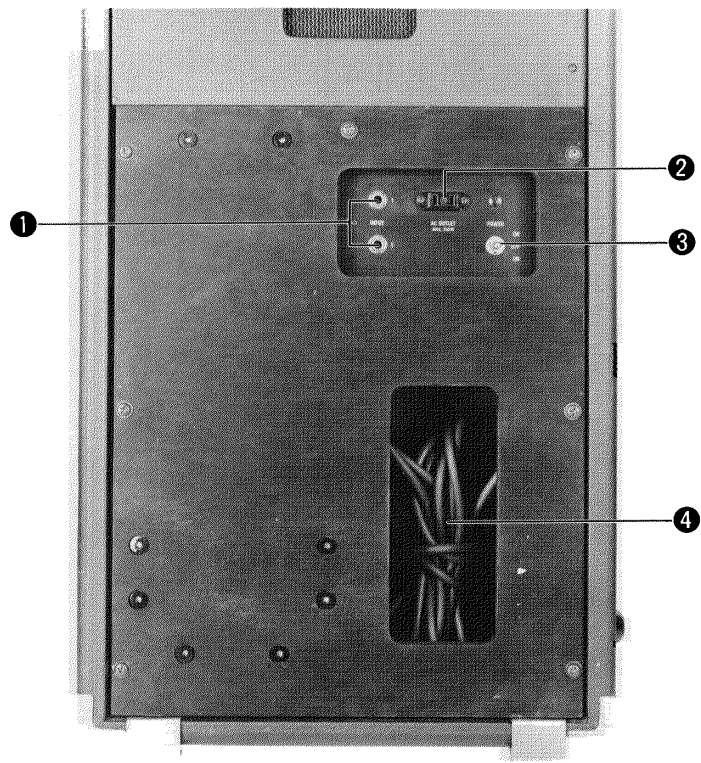

### ❶ Input Jacks

Connect to the PM-200B Out jack. Input power of  $-6\text{dBm}$  provides maximum output. Either of the two input jacks can be connected to another power amp/speaker for extra power.

### ❷ AC Outlet (not provided in certain areas)

### ❸ Power Switch

Pick the ON position which affords the lower hum level. (except European and Australian models)

### ❹ Power Cord

# PS-100B/75B SPECIFICATIONS

	PS-100B	PS-75B
OUTPUT POWER	100 Wrms	60 Wrms
SPEAKERS	JA-2057 20cm(8") x 5	JA-2057 20cm(8") x 8
FITTINGS	Input Jacks (1, 2)	Input Jacks (1, 2)
POWER CONSUMPTION	250 W	120 W
CIRCUITRY	Solid State	Solid State
DIMENSIONS (W x D x H)	42 x 23.7 x 157.8 cm (16½ x 9¼ x 62¼")	42 x 23.7 x 102.3cm (16½ x 9¼x 40¼")
WEIGHT	43 kg (94.8 lbs.)	28 kg (61.7 lbs.)

TERMINAL	NOMINAL LEVEL	IMPEDANCE
Input	-6 dBm (0.39 Vrms)	10K $\Omega$

SINCE 1887  **YAMAHA**  
NIPPON GAKKI CO., LTD. HAMAMATSU, JAPAN